



S17, S17 Pro, T17 Server Installation Guide

Document Version 0.1

May. 2019

© Copyright Bitmaintech Pte.Ltd. 2007 – 2019. All rights reserved.

Bitmaintech Pte.Ltd. (Bitmain) reserves the right to make corrections, modifications, enhancements, improvements, and other changes to its products and services at any time and to discontinue any product or service without notice.

Customers should obtain the latest relevant information before placing orders and should verify that such information is current and complete. All products are sold subject to Bitmain's terms and conditions of sale supplied at the time of order acknowledgment.

Bitmain warrants performance of its products to the specifications applicable at the time of sale in accordance with Bitmain's standard warranty. Testing and other quality control techniques are used to the extent Bitmain deems necessary to support this warranty. Except where mandated by government requirements, testing of all parameters of each product is not necessarily performed.

Bitmain assumes no liability for third-party applications assistance. Customers are responsible for their products and applications using Bitmain components. To minimize the risks associated with customer products and applications, customers should provide adequate design and operating safeguards.

Bitmain does not warrant or represent that any license, either express or implied, is granted under any Bitmain patent right, copyright or other Bitmain intellectual property right relating to any combination, machine, or process in which Bitmain products or services are used. Information published by Bitmain regarding third-party products or services does not constitute a license from Bitmain to use such products or services or a warranty or endorsement thereof. Use of such information may require a license from a third party under the patents or other intellectual property of the third party, or a license from Bitmain under the patents or other intellectual property of Bitmain.

Resale of Bitmain products or services with statements different from or beyond the parameters stated by Bitmain for that product or service voids all express and any implied warranties for the associated Bitmain product or service and is an unfair and deceptive business practice. Bitmain is not responsible or liable for any such statements.

All company and brand products and service names are trademarks or registered trademarks of their respective holders.

All text and figures included in this publication are the exclusive property of Bitmaintech Pte.Ltd. (Bitmain), and may not be copied, reproduced, or used in any way without the express written permission of Bitmain. Information in this document is subject to change without notice and does not represent a commitment on the part of Bitmain. Although the information in this document has been carefully reviewed, Bitmain does not warrant it to be free of errors or omissions. Bitmain reserves the right to make corrections, updates, revisions or changes to the information in this document.

Bitmaintech Pte.Ltd.
Tel:+86-400-890-8855
www.bitmain.com

Table of Contents

1. Overview.....	4
1.1 S17, S17 Pro, T17 Server Components.....	5
1.2 Specifications.....	7
2. Setting Up the Server.....	17
3. Configuring the Server.....	19
4. Monitoring Your Server.....	21
5. Administering Your Server.....	23
5.1 Checking Your Firmware Version.....	23
5.2 Upgrading Your System.....	24
5.3 Modifying Your Password.....	25
5.4 Restoring Initial Settings.....	25
Environmental Requirements.....	26
Regulations.....	28

1. Overview

The S17, S17 Pro, T17 servers are Bitmain's newest versions in the 17 server series. Power supply APW9 is part of S17, S17 Pro, T17 servers. All S17, S17 Pro, T17 servers are tested and configured prior to shipping to ensure easy set up. Here takes pictures of S17 server as examples:



Front View



Back View



Placement

Caution:

- 1.The equipment must be connected to an earthed mains socket-outlet. The socket-outlet shall be installed near the equipment and shall be easily accessible.
- 2.The equipment has two power inputs, only by connecting those two power supply sockets simultaneously can the equipment run. When the equipment is powered off, be sure to power off all power inputs.
- 3.Please refer to the layout above to place your goods in usage in case of any damage.

1.1 S17, S17 Pro, T17 Server Components

The main components and controller front panel of S17, S17 Pro, T17 servers are shown in the following figure (here takes pictures of S17 server as examples):

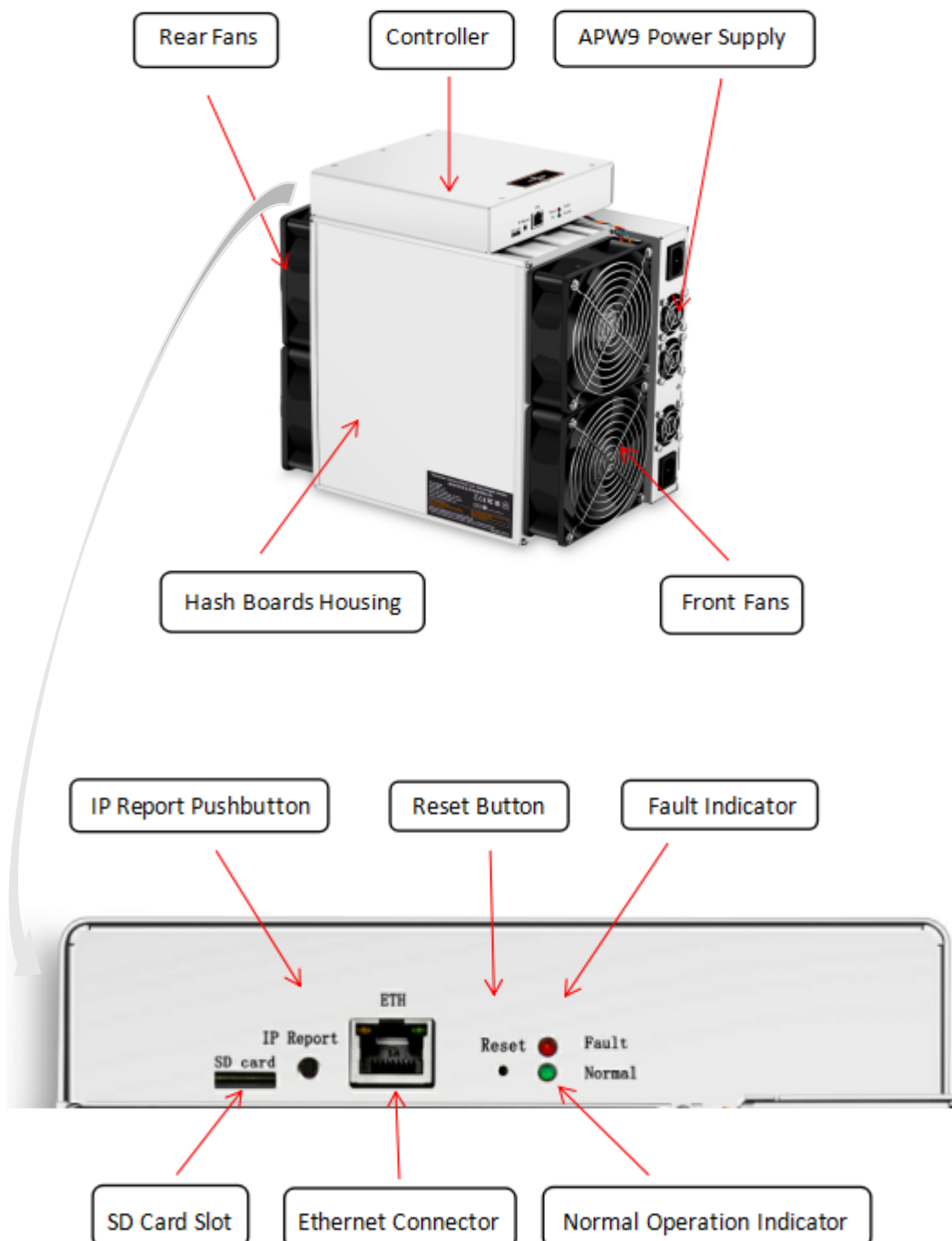

APW9 Power Supply:

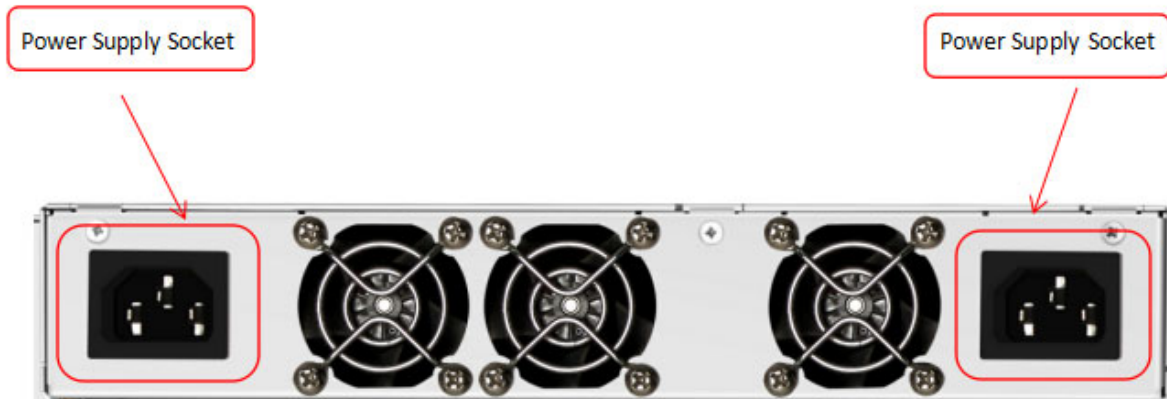

Note:



1.Power supply APW9 is part of S17, S17 Pro, T17 servers. For detailed parameters, please refer to the specifications below.

2.Additional two power cords are needed.

1.2 Specifications

Model No.: 240-Aa

Version: S17-53T

Product Glance	Value	
	Low Power	Normal
Crypto Algorithm/Coins	SHA256/BTC/BCH	
Hashrate, TH/s	35~50.00	53.00
Reference power on wall, Watt	1470~2100	2385
Reference power efficiency on wall @25°C, J/TH	42.00	45.00

Detailed Characteristics	Value		
	Min	Typ	Max
Hashrate & Power			
Hashrate, TH/s	Low Power	35~50.00	+3% ⁽¹⁻¹⁾
	Normal	53.00	55.95
Power efficiency on wall @25°C, J/TH	Low Power	42.00	46.20
	Normal	45.00	49.50
Power efficiency on wall @40°C, J/TH	Low Power	43.81	48.19
	Normal	46.47	51.11
Power on wall, Watt ⁽¹⁻²⁾	Low Power	1470~2100	2482
	Normal	2385	2860
Power supply AC input voltage, Volt ⁽¹⁻³⁾	200	220	240
Power supply AC input current, Amp ⁽¹⁻⁴⁾	Low Power	6.68~9.55	12.41
	Normal	10.84	14.30
Power supply Input AC Frequency Range, Hz	47	50	63
Hardware Configuration			
Quantity of hash chips	144		
Quantity of hash boards	3		
Networking connection mode	RJ45 Ethernet 10/100M		

Server Size (Length*Width*Height, w/o package),mm ⁽²⁻¹⁾	298.2*178.0*296.6			
Net weight, kg ⁽²⁻²⁾	9.50			
Noise, dBA @25°C ⁽²⁻³⁾				82
Environmental Requirements				
Operation temperature,°C		0	25	40
Storage temperature,°C		-20	25	70
Operation humidity, RH(no condensation)		10%		90%

Notes:

- (1-1) In Low Power Mode, Max Hashrate is about **Typ Hashrate *103%**
- (1-2) Min condition: 25°C, min J/TH, typical Hashrate
Max condition: 40°C, max J/TH, max Hashrate
- (1-3) Caution: Wrong input voltage may probably cause server damaged**
- (1-4) Typ condition: min reference power, typical AC input voltage
Max condition: max reference power, min AC input voltage
- (2-1) Including PSU size
- (2-2) Including PSU weight
- (2-3) Max condition: Fan is under max RPM(rotation per minute).

Model No.: 240-Aa

Version: S17-56T

Product Glance	Value	
	Low Power	Normal
Crypto Algorithm/Coins	SHA256/BTC/BCH	
Hashrate, TH/s	35.00~50.00	56.00
Reference power on wall, Watt	1470~2100	2520
Reference power efficiency on wall @25°C, J/TH	42.00	45.00

Detailed Characteristics		Value		
		Min	Typ	Max
Hashrate & Power				
Hashrate, TH/s	Low Power		35~50.00	+3% ⁽¹⁻¹⁾
	Normal		56.00	58.95
Power efficiency on wall @25°C, J/TH	Low Power	42.00		46.20
	Normal	45.00		49.50
Power efficiency on wall @40°C, J/TH	Low Power	43.98		48.38
	Normal	47.42		52.17
Power on wall, Watt ⁽¹⁻²⁾	Low Power	1470 ~2100		2492
	Normal	2520		3075
Power supply AC input voltage, Volt ⁽¹⁻³⁾		200	220	240
Power supply AC input current, Amp ⁽¹⁻⁴⁾	Low Power		6.68~9.55	12.46
	Normal		11.45	15.38
Power supply Input AC Frequency Range, Hz		47	50	63
Hardware Configuration				
Quantity of hash chips	144			
Quantity of hash boards	3			
Networking connection mode	RJ45 Ethernet 10/100M			
Server Size (Length*Width*Height, w/o package), mm ⁽²⁻¹⁾	298.2*178.0*296.6			
Net weight, kg ⁽²⁻²⁾	9.50			

Noise, dBA @25°C ⁽²⁻³⁾				82
Environmental Requirements				
Operation temperature, °C		0	25	40
Storage temperature, °C		-20	25	70
Operation humidity, RH(no condensation)		10%		90%

Notes:

- (1-1) In Low Power Mode, Max Hashrate is about **Typ Hashrate *103%**
- (1-2) Min condition: 25°C, min J/TH, typical Hashrate
Max condition: 40°C, max J/TH, max Hashrate
- (1-3) Caution: Wrong input voltage may probably cause server damaged**
- (1-4) Typ condition: min reference power, typical AC input voltage
Max condition: max reference power, min AC input voltage
- (2-1) Including PSU size
- (2-2) Including PSU weight
- (2-3) Max condition: Fan is under max RPM(rotation per minute).

Model No.: 240-Aa
Version: S17 Pro-50T

Product Glance	Value		
	Low Power	Normal	Turbo
Crypto Algorithm/Coins	SHA256/BTC/BCH		
Hashrate, TH/s	36~48.00	50.00	50~62.00
Reference power on wall, Watt	1296~1728	1975	2250~2790
Reference power efficiency on wall @25°C, J/TH	36.00	39.50	45.00

Detailed Characteristics	Value			
	Min	Typ	Max	
Hashrate & Power				
Hashrate, TH/s	Low Power		36~48.00	+3% ⁽¹⁻¹⁾
	Normal		50.00	52.95
	Turbo		50~62.00	+3% ⁽¹⁻²⁾
Power efficiency on wall @25°C, J/TH	Low Power	36.00		39.60
	Normal	39.50		43.45
	Turbo	45.00		49.50
Power efficiency on wall @40°C, J/TH	Low Power	38.30		42.12
	Normal	41.50		45.64
	Turbo	47.25		51.98
Power on wall, Watt ⁽¹⁻³⁾	Low Power	1296~1728		2082
	Normal	1975		2417
	Turbo	2250~2790		3319
Power supply AC input voltage, Volt ⁽¹⁻⁴⁾		200	220	240
Power supply AC input current, Amp ⁽¹⁻⁵⁾	Low Power		5.89~7.85	10.41
	Normal		8.98	12.08
	Turbo		10.23~12.68	16.60
Power supply Input AC Frequency Range, Hz		47	50	63
Hardware Configuration				

Quantity of hash chips	144			
Quantity of hash boards	3			
Networking connection mode	RJ45 Ethernet 10/100M			
Server Size (Length*Width*Height, w/o package),mm ⁽²⁻¹⁾	298.2*178.0*296.6			
Net weight, kg ⁽²⁻²⁾	9.50			
Noise, dBA @25°C ⁽²⁻³⁾				82
Environmental Requirements				
Operation temperature,°C		0	25	40
Storage temperature,°C		-20	25	70
Operation humidity, RH(no condensation)		10%		90%

Notes:

- (1-1) In Low Power Mode, Max Hashrate is about **Typ Hashrate *103%**
- (1-2) In Turbo Mode, Max Hashrate is about **Typ Hashrate *103%**
- (1-3) Min condition: 25°C, min J/TH, typical Hashrate
Max condition: 40°C, max J/TH, max Hashrate
- (1-4) Caution: Wrong input voltage may probably cause server damaged**
- (1-5) Typ condition: min reference power, typical AC input voltage
Max condition: max reference power, min AC input voltage
- (2-1) Including PSU size
- (2-2) Including PSU weight
- (2-3) Max condition: Fan is under max RPM(rotation per minute).

Model No.: 240-Aa
Version: S17 Pro-53T

Product Glance	Value		
	Low Power	Normal	Turbo
Crypto Algorithm/Coins	SHA256/BTC/BCH		
Hashrate, TH/s	36~48.00	53.00	53~62.00
Reference power on wall, Watt	1296~1728	2094	2385~2790
Reference power efficiency on wall @25°C, J/TH	36.00	39.50	45.00

Detailed Characteristics	Value			
		Min	Typ	Max
Hashrate & Power				
Hashrate, TH/s	Low Power		36~48.00	+3% ⁽¹⁻¹⁾
	Normal		53.00	55.95
	Turbo		53~62.00	+3% ⁽¹⁻²⁾
Power efficiency on wall @25°C, J/TH	Low Power	36.00		39.60
	Normal	39.50		43.45
	Turbo	45.00		49.50
Power efficiency on wall @40°C, J/TH	Low Power	38.22		42.05
	Normal	41.73		45.90
	Turbo	47.99		52.79
Power on wall, Watt ⁽¹⁻³⁾	Low Power	1296~1728		2079
	Normal	2094		2568
	Turbo	2385~2790		3371
Power supply AC input voltage, Volt ⁽¹⁻⁴⁾		200	220	240
Power supply AC input current, Amp ⁽¹⁻⁵⁾	Low Power		5.89~7.85	10.40
	Normal		9.52	12.84
	Turbo		10.84~12.68	16.86
Power supply Input AC Frequency Range, Hz		47	50	63

Hardware Configuration				
Quantity of hash chips	144			
Quantity of hash boards	3			
Networking connection mode	RJ45 Ethernet 10/100M			
Server Size (Length*Width*Height, w/o package),mm ⁽²⁻¹⁾	298.2*178.0*296.6			
Net weight, kg ⁽²⁻²⁾	9.50			
Noise, dBA @25°C ⁽²⁻³⁾				82
Environmental Requirements				
Operation temperature,°C		0	25	40
Storage temperature,°C		-20	25	70
Operation humidity, RH(no condensation)		10%		90%

Notes:

- (1-1) In Low Power Mode, Max Hashrate is about **Typ Hashrate *103%**
- (1-2) In Turbo Mode, Max Hashrate is about **Typ Hashrate *103%**
- (1-3) Min condition: 25°C, min J/TH, typical Hashrate
Max condition: 40°C, max J/TH, max Hashrate
- (1-4) Caution: Wrong input voltage may probably cause server damaged**
- (1-5) Typ condition: min reference power, typical AC input voltage
Max condition: max reference power, min AC input voltage
- (2-1) Including PSU size
- (2-2) Including PSU weight
- (2-3) Max condition: Fan is under max RPM(rotation per minute).

Model No.: 240-Aa

Version: T17-40T

Product Glance	Value
Crypto Algorithm/Coins	SHA256/BTC/BCH
Hashrate, TH/s	40.00
Reference power on wall, Watt	2200
Reference power efficiency on wall @25°C, J/TH	55.00

Detailed Characteristics	Value		
	Min	Typ	Max
Hashrate & Power			
Hashrate, TH/s		40.00	40.45
Power efficiency on wall @25°C, J/TH	55.00		58.85
Power efficiency on wall @40°C, J/TH	58.26		62.34
Power on wall, Watt ⁽¹⁻¹⁾	2200		2522
Power supply AC input voltage, Volt ⁽¹⁻²⁾	200	220	240
Power supply AC input current, Amp ⁽¹⁻³⁾		10.00	12.61
Power supply Input AC Frequency Range, Hz	47	50	63
Hardware Configuration			
Quantity of hash chips	90		
Quantity of hash boards	3		
Networking connection mode	RJ45 Ethernet 10/100M		
Server Size (Length*Width*Height, w/o package), mm ⁽²⁻¹⁾	298.2*178.0*296.6		
Net weight, kg ⁽²⁻²⁾	9.73		
Noise, dBA @25°C ⁽²⁻³⁾			82
Environment Requirements			
Operation temperature, °C	0	25	40
Storage temperature, °C	-20	25	70
Operation humidity, RH (no condensation)	10%		90%

Notes:

- (1-1) Min condition: 25°C, min J/TH, typical Hashrate
Max condition: 40°C, max J/TH, max Hashrate
- (1-2) Caution: Wrong input voltage may probably cause server damaged**
- (1-3) Typ condition: min reference power, typical AC input voltage
Max condition: max reference power, min AC input voltage
- (2-1) Including PSU size
- (2-2) Including PSU weight
- (2-3) Max condition: Fan is under max RPM(rotation per minute).

2. Setting Up the Server

To set up the server:



The file IPReporter.zip is supported by Microsoft Windows only.

1. Go to the following site:
<https://shop.bitmain.com/support.htm?pid=00720160906053730999PVD2K0vz0693>
2. Download the following file: IPReporter.zip.
3. Extract the file.



The default DHCP network protocol distributes IP addresses automatically.

4. Right-click **IPReporter.exe** and run it as Administrator.
5. Select one of the following options:
 - Shelf, Step, Position – suitable for farm servers to mark the location of the servers.
 - Default – suitable for home servers.
6. Click **Start**.

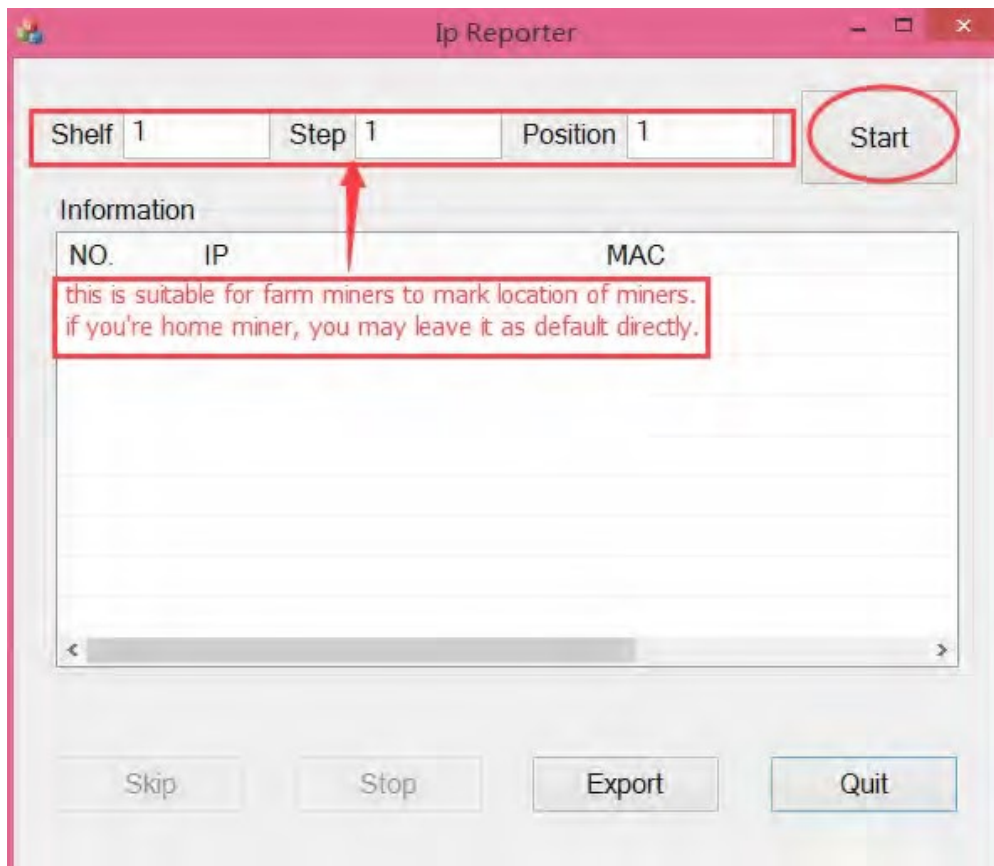

- On the controller board, click the IP Report button. Hold it down until it beeps (about 5 seconds).

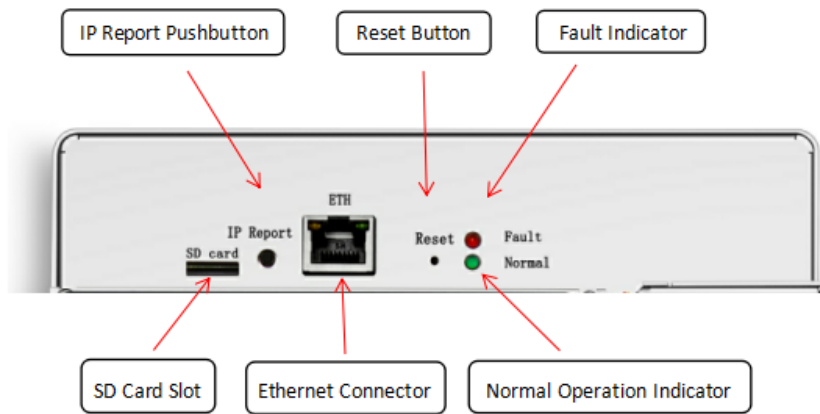

The IP address will be displayed in a window on your computer screen.

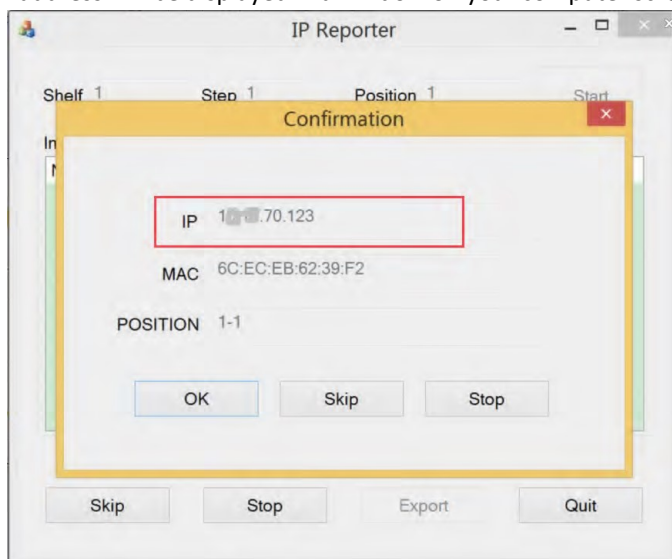

- In your web browser, enter the IP address provided.
- Proceed to login using root for both the username and password.
- In the Network section, you can assign a DHCP IP address (optional).
- Click **Save & Apply**.

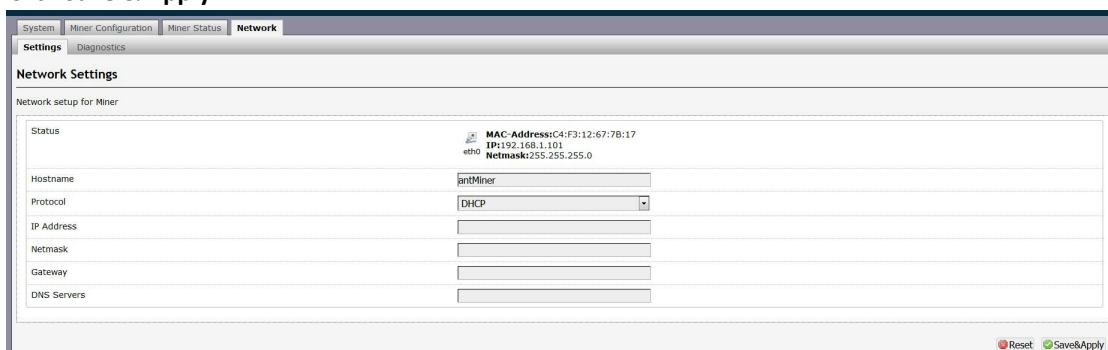

3. Configuring the Server

Setting Up the Pool

To configure the server:

1. click **General Settings**.

S17 Server:

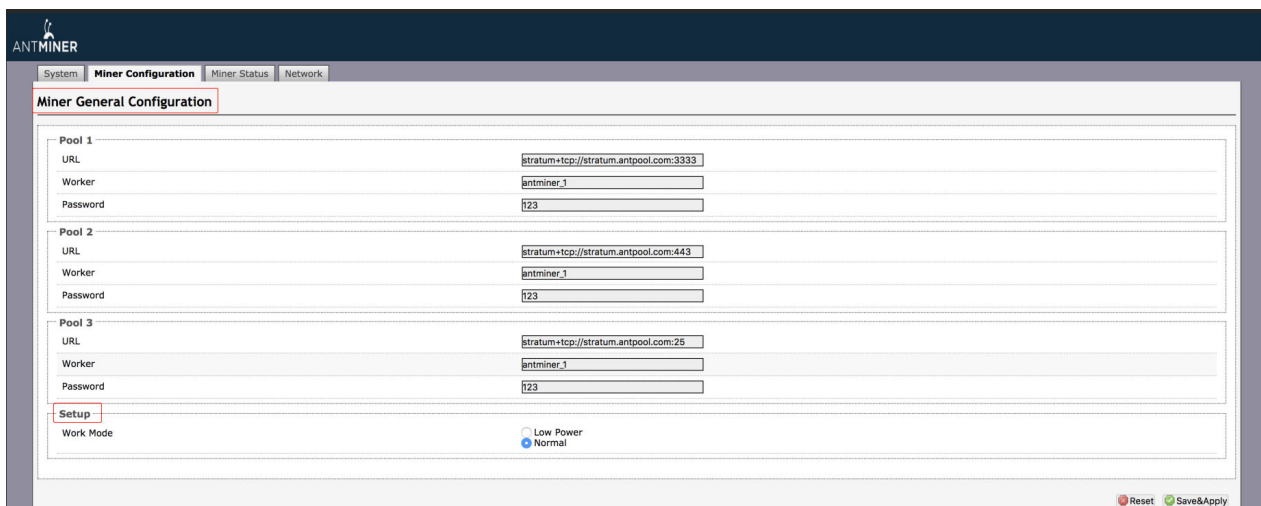

The screenshot shows the ANTMINER web interface for the S17 Server. The 'Miner Configuration' tab is active, and the 'Miner General Configuration' section is highlighted. It contains three pool configuration sections (Pool 1, Pool 2, Pool 3) and a 'Setup' section. Each pool section has fields for URL, Worker, and Password. The 'Setup' section has a 'Work Mode' dropdown menu.

Pool	URL	Worker	Password
Pool 1	stratum+tcp://stratum.antpool.com:3333	antminer_1	f123
Pool 2	stratum+tcp://stratum.antpool.com:443	antminer_1	f123
Pool 3	stratum+tcp://stratum.antpool.com:25	antminer_1	f123

Setup
Work Mode: Low Power Normal

S17 Pro Server:

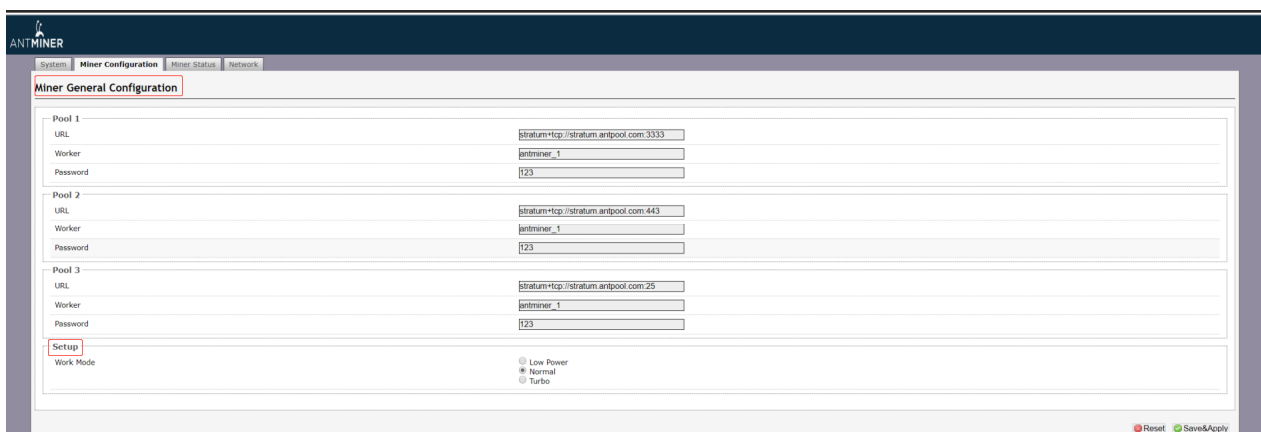



The screenshot shows the ANTMINER web interface for the S17 Pro Server. The 'Miner Configuration' tab is active, and the 'Miner General Configuration' section is highlighted. It contains three pool configuration sections (Pool 1, Pool 2, Pool 3) and a 'Setup' section. Each pool section has fields for URL, Worker, and Password. The 'Setup' section has a 'Work Mode' dropdown menu.

Pool	URL	Worker	Password
Pool 1	stratum+tcp://stratum.antpool.com:3333	antminer_1	f123
Pool 2	stratum+tcp://stratum.antpool.com:443	antminer_1	f123
Pool 3	stratum+tcp://stratum.antpool.com:25	antminer_1	f123

Setup
Work Mode: Low Power Normal Turbo

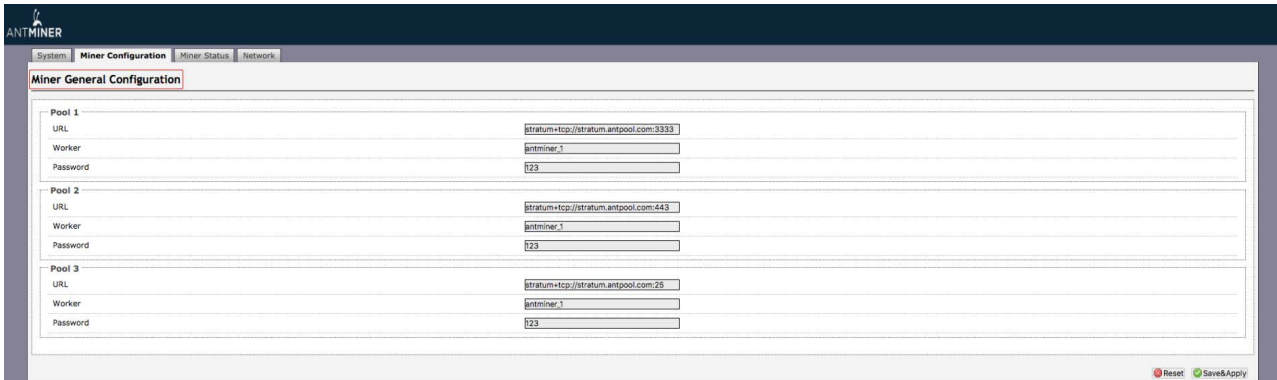
T17 Server:



 **Note:** There are three modes of Hashrate which u may adjust for S17 Pro server: Low Power mode, Normal Mode and Turbo mode (High Performance Mode); two modes for S17 server: Low Power mode and Normal mode. Power consumption varies with different mode. Please refer to the specifications above for more details.

2. Set the options according to the following table:

Option	Description
Pool URL	Enter the URL of your desired pool. <div data-bbox="400 1249 1391 1458" style="border: 1px solid black; padding: 10px; margin-top: 10px;">  <p>The S17, S17 Pro, T17 servers can be set up with three mining pools, with decreasing priority from the first pool (pool 1) to the third pool (pool 3). The pools with low priority will only be used if all higher priority pools are offline.</p> </div>
Worker	Your worker ID on the selected pool.
Password	The password for your selected worker.

3. Click Save & Apply to save and restart the server.

4. Monitoring Your server

To check the operating status of your server:

1. Click the status marked below.

Here is an example of S17-53T server running under Normal mode:

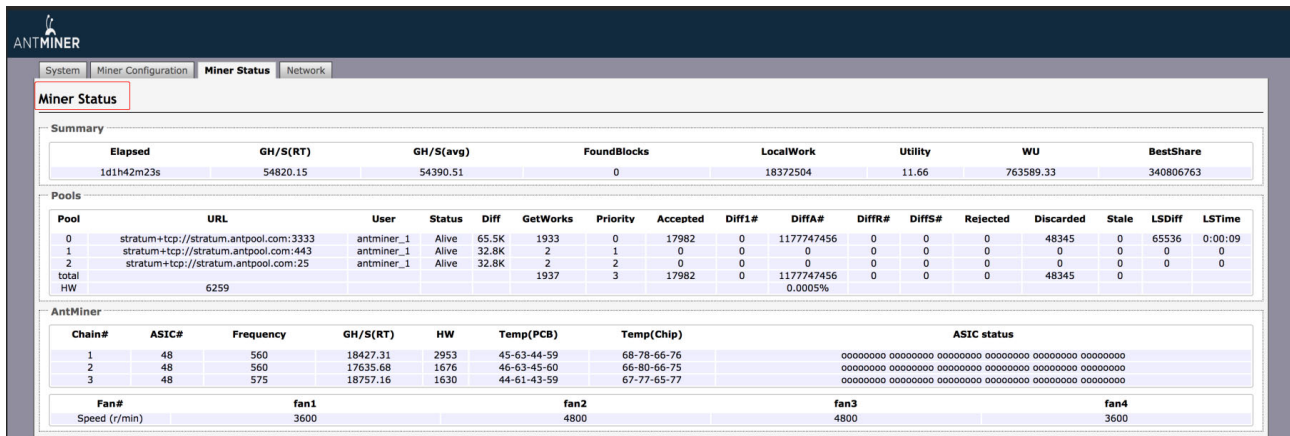

The screenshot shows the 'Miner Status' page with the following data:

Summary															
Elapsed	GH/S(RT)	GH/S(avg)	FoundBlocks	LocalWork	Utility	WU	BestShare								
1d1h42m23s	54820.15	54390.51	0	18372504	11.66	763589.33	340806763								

Pools																
Pool	URL	User	Status	Diff	GetWorks	Priority	Accepted	Diff1#	DiffA#	DiffR#	DiffS#	Rejected	Discarded	Stale	LSDiff	LSTime
0	stratum+tcp://stratum.antpool.com:3333	antminer_1	Alive	65.5K	1933	0	17982	0	1177747456	0	0	0	48345	0	65536	0:00:09
1	stratum+tcp://stratum.antpool.com:443	antminer_1	Alive	32.8K	2	1	0	0	0	0	0	0	0	0	0	0
2	stratum+tcp://stratum.antpool.com:25	antminer_1	Alive	32.8K	2	2	0	0	0	0	0	0	0	0	0	0
total					1937	3	17982	0	1177747456	0	0	0	48345	0		
HW	6259								0.0005%							

AntMiner															
Chain#	ASIC#	Frequency	GH/S(RT)	HW	Temp(PCB)	Temp(Chip)	ASIC status								
1	48	560	18427.31	2953	45-63-44-59	68-78-66-76	00000000 00000000 00000000 00000000 00000000 00000000								
2	48	560	17635.68	1676	46-63-45-60	66-80-66-75	00000000 00000000 00000000 00000000 00000000 00000000								
3	48	575	18757.16	1630	44-61-43-59	67-77-65-77	00000000 00000000 00000000 00000000 00000000 00000000								

Fan#				
Speed (r/min)	fan1	fan2	fan3	fan4
	3600	4800	4800	3600

Here is an example of S17 Pro- 53T server running under Turbo mode:

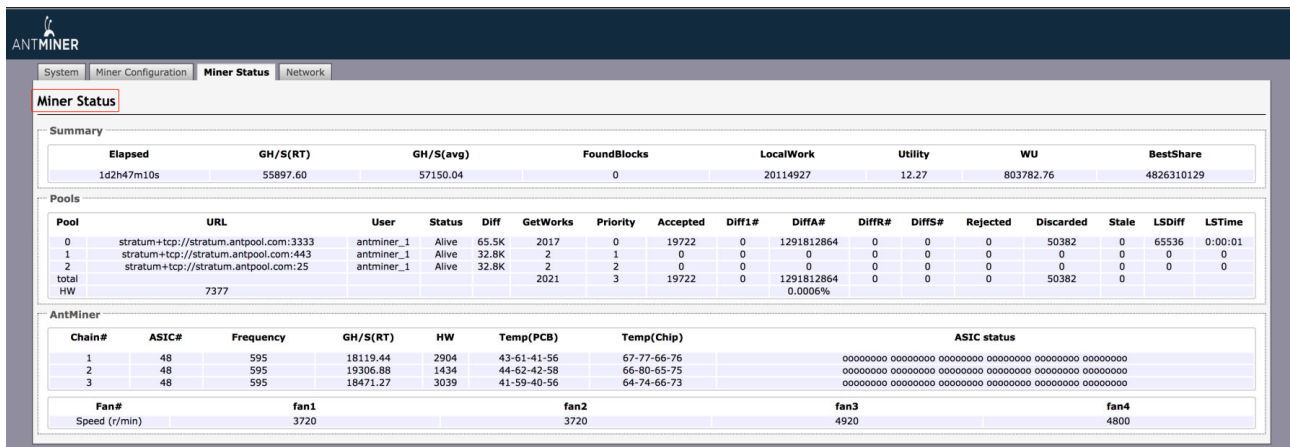

The screenshot shows the 'Miner Status' page with the following data:

Summary															
Elapsed	GH/S(RT)	GH/S(avg)	FoundBlocks	LocalWork	Utility	WU	BestShare								
1d2h47m10s	55897.60	57150.04	0	20114927	12.27	803782.76	4826310129								

Pools																
Pool	URL	User	Status	Diff	GetWorks	Priority	Accepted	Diff1#	DiffA#	DiffR#	DiffS#	Rejected	Discarded	Stale	LSDiff	LSTime
0	stratum+tcp://stratum.antpool.com:3333	antminer_1	Alive	65.5K	2017	0	19722	0	1291812864	0	0	0	50382	0	65536	0:00:01
1	stratum+tcp://stratum.antpool.com:443	antminer_1	Alive	32.8K	2	1	0	0	0	0	0	0	0	0	0	0
2	stratum+tcp://stratum.antpool.com:25	antminer_1	Alive	32.8K	2	2	0	0	0	0	0	0	0	0	0	0
total					2021	3	19722	0	1291812864	0	0	0	50382	0		
HW	7377								0.0006%							

AntMiner															
Chain#	ASIC#	Frequency	GH/S(RT)	HW	Temp(PCB)	Temp(Chip)	ASIC status								
1	48	595	18119.44	2904	43-61-41-56	67-77-66-76	00000000 00000000 00000000 00000000 00000000 00000000								
2	48	595	19306.88	1434	44-62-42-58	66-80-65-75	00000000 00000000 00000000 00000000 00000000 00000000								
3	48	595	18471.27	3039	41-59-40-56	64-74-66-73	00000000 00000000 00000000 00000000 00000000 00000000								

Fan#				
Speed (r/min)	fan1	fan2	fan3	fan4
	3720	3720	4920	4800

Here is an example of T17-40T server:

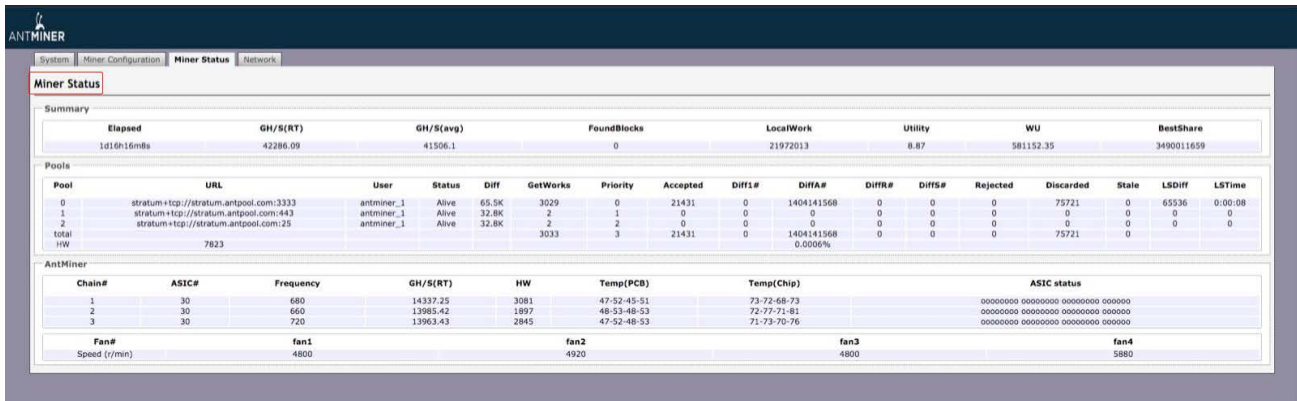

The screenshot shows the 'Miner Status' page with the following data:

Summary									
Elapsed	GH/S(RT)	GH/S(ava)	FoundBlocks	LocalWork	Utility	WU	BestShare		
1d16h16m8s	42286.09	41506.1	0	21972013	8.87	581152.35	3490011659		

Pool	URL	User	Status	Diff	GetWorks	Priority	Accepted	Diff1#	DiffA#	DiffR#	DiffS#	Rejected	Discarded	Stale	LSDiff	LSTime
0	stratum+tcp://stratum.antpool.com:3333	antminer_1	Alive	65.5K	3029	0	21431	0	1404:41568	0	0	0	75721	0	65536	0:00:08
1	stratum+tcp://stratum.antpool.com:443	antminer_1	Alive	32.8K	2	1	0	0	0	0	0	0	0	0	0	0
2	stratum+tcp://stratum.antpool.com:25	antminer_1	Alive	32.8K	2	2	0	0	0	0	0	0	0	0	0	0
total					3033	3	21431	0	1404:41568	0	0	0	75721	0		
HW	7823															0.0000%

Chain#	ASIC#	Frequency	GH/S(RT)	HW	Temp(PCB)	Temp(Chip)	ASIC status
1	30	680	14337.25	3081	47-52-45-51	73-72-68-73	00000000 00000000 00000000 00000000
2	30	660	13865.42	1897	48-53-48-53	72-77-71-81	00000000 00000000 00000000 00000000
3	30	720	13963.43	2845	47-52-48-53	71-73-70-76	00000000 00000000 00000000 00000000

Fan#	Speed (r/min)	fan1	fan2	fan3	fan4
	4800	4800	4920	4800	5880

Note: The S17, S17 Pro, T17 servers are with automatic frequency. Firmware will stop running when the Temp (PCB) reaches to 75°C or Temp(chips) reaches to 100°C, there will be an error message “Fatal Error: Temperature is too high!” shown in the bottom of kernel log page.

2. Monitor your server according to the descriptions in the following table:

Option	Description
ASIC#	Number of chips detected in the chain.
Frequency	ASIC frequency setting.
GH/S(RT)	Hash rate of each hash board (GH/s).
Temp(PCB)	Temperature of each hash board (°C). (Applied only to server with fixed frequency).
Temp(Chip)	Temperature of the chips on each hash board (°C).
ASIC status	One of the following statuses will appear: <ul style="list-style-type: none"> ● O - indicates OK ● X - indicates error ● - - indicates dead

5. Administering Your Server

5.1 Checking Your Firmware Version

To check your firmware version:

1. In **System**, click the **Overview** tab.
2. **File System Version** displays the date of the firmware your server uses. In the examples below, the servers are respectively using firmware version 20190408 and 20190426.

S17 Server:

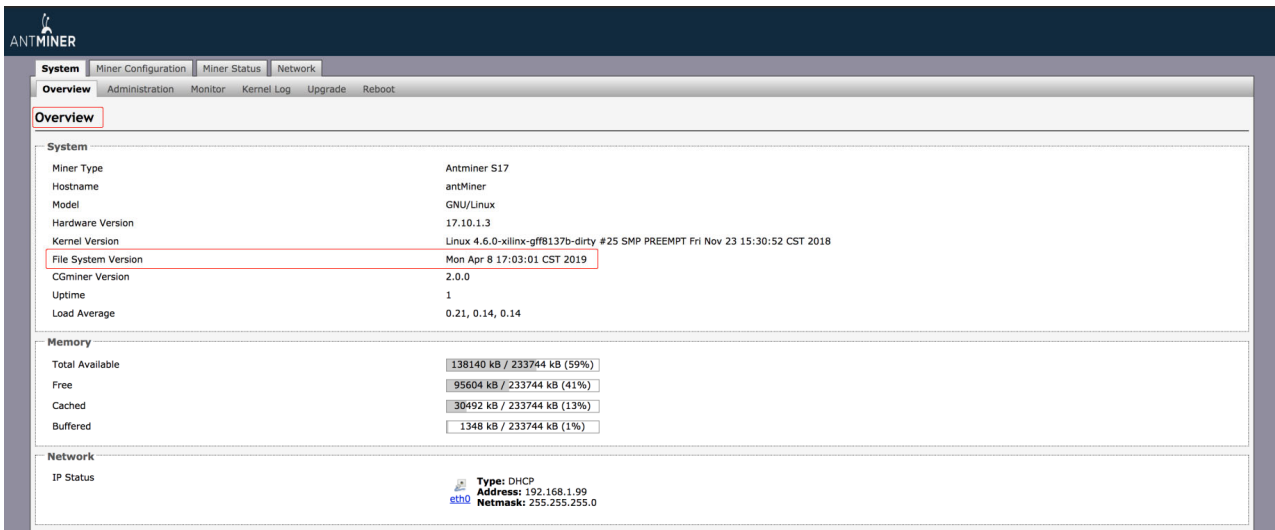

The screenshot shows the Antminer S17 Overview page. The 'File System Version' is highlighted with a red box and shows 'Mon Apr 8 17:03:01 CST 2019'. Other system information includes Miner Type (Antminer S17), Hostname (antMiner), Model (GNU/Linux), Hardware Version (17.10.1.3), Kernel Version (Linux 4.6.0-xilinx-gf8137b-dirty #25 SMP PREEMPT Fri Nov 23 15:30:52 CST 2018), CGminer Version (2.0.0), Uptime (1), and Load Average (0.21, 0.14, 0.14). Memory usage is shown as 138140 kB / 233744 kB (59%) available, 95604 kB / 233744 kB (41%) free, 30492 kB / 233744 kB (13%) cached, and 1348 kB / 233744 kB (1%) buffered. Network status shows IP Status with Type: DHCP, Address: 192.168.1.99, and Netmask: 255.255.255.0.

S17 Pro Server:

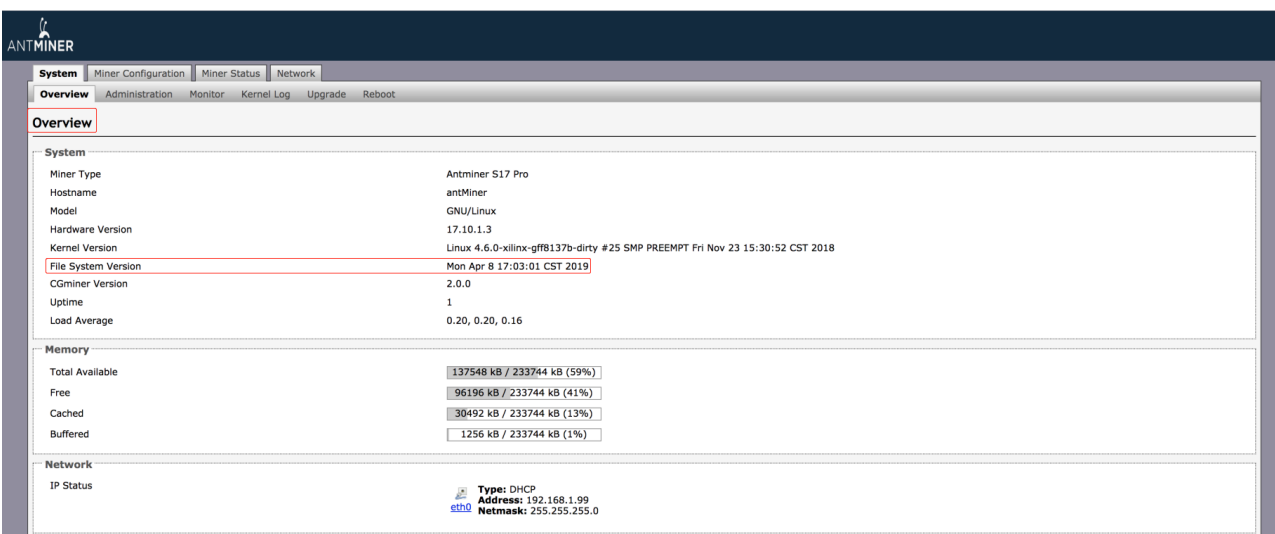

The screenshot shows the Antminer S17 Pro Overview page. The 'File System Version' is highlighted with a red box and shows 'Mon Apr 8 17:03:01 CST 2019'. Other system information includes Miner Type (Antminer S17 Pro), Hostname (antMiner), Model (GNU/Linux), Hardware Version (17.10.1.3), Kernel Version (Linux 4.6.0-xilinx-gf8137b-dirty #25 SMP PREEMPT Fri Nov 23 15:30:52 CST 2018), CGminer Version (2.0.0), Uptime (1), and Load Average (0.20, 0.20, 0.16). Memory usage is shown as 137548 kB / 233744 kB (59%) available, 96196 kB / 233744 kB (41%) free, 30492 kB / 233744 kB (13%) cached, and 1256 kB / 233744 kB (1%) buffered. Network status shows IP Status with Type: DHCP, Address: 192.168.1.99, and Netmask: 255.255.255.0.

T17 Server:

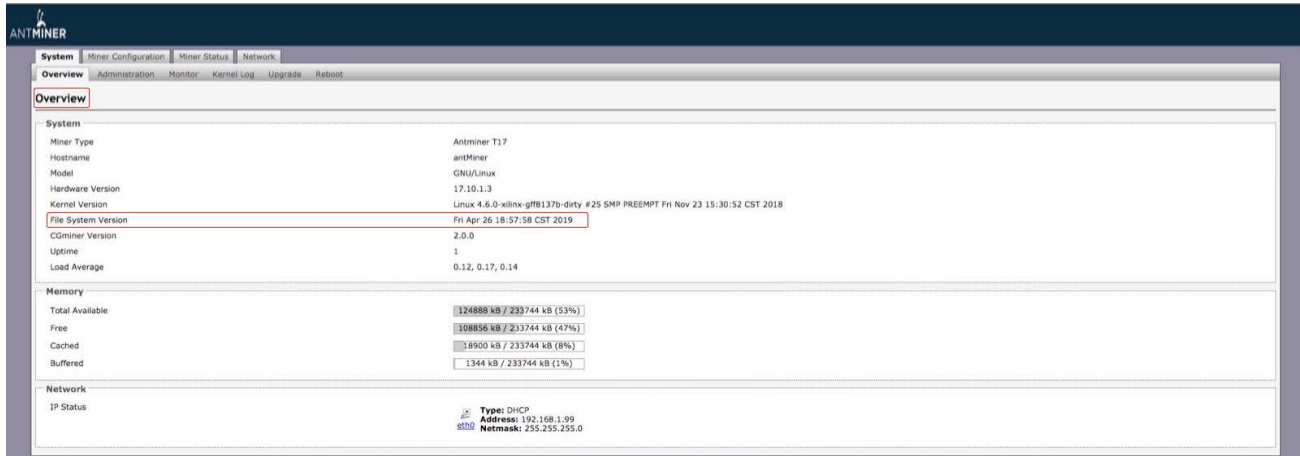

5.2 Upgrading Your System

 Make sure that the S17, S17 Pro, T17 servers remain powered during the upgrade process. If power fails before the upgrade is completed, you will need to return it to Bitmain for repair.

To upgrade the server's firmware:

1. In System, click **Upgrade**.

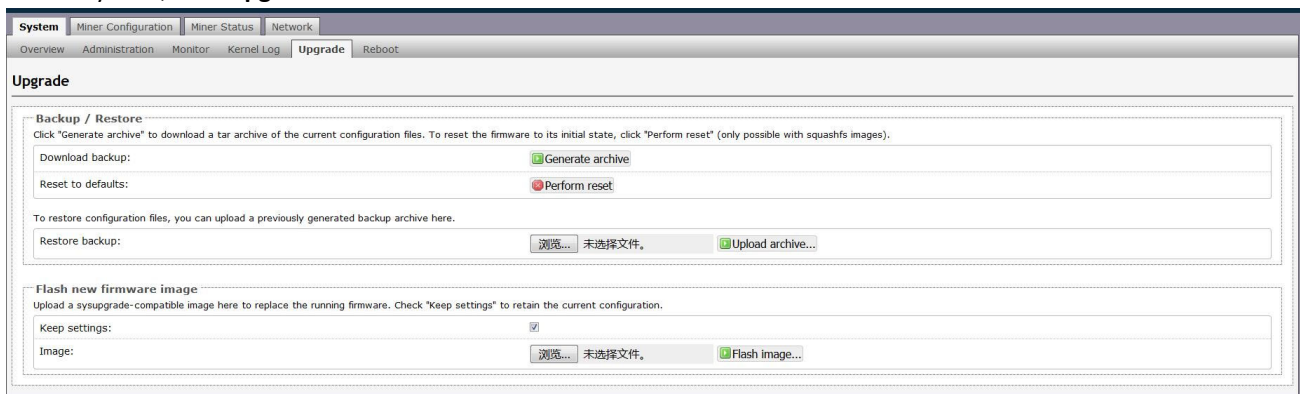

2. For **Keep Settings**:
 - Select the check box to keep your current settings (default).
 - Clear the check box to reset the server to default settings.
3. Click the **选择文件 (Browse)** button and navigate to the upgrade file. Select the upgrade file, then click **Flash image**. A message appears notifying you if the S17, S17 Pro, T17 firmwares can be upgraded and if yes, will then proceed to flash the image.

- When the upgrade is completed, the following message appears:

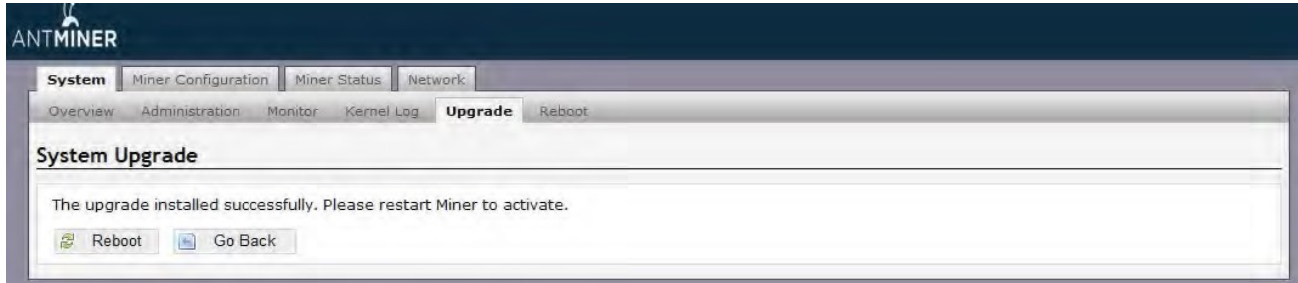

- Click one of the following options:
 - **Reboot** - to restart the server with the new firmware.
 - **Go Back** - to continue mining with the current firmware. The server will load the new firmware next time when it is restarted.

5.3 Modifying Your Password

To change your login password:

- In **System**, click the **Administration** tab.
- Set your new password, then click **Save & Apply**.

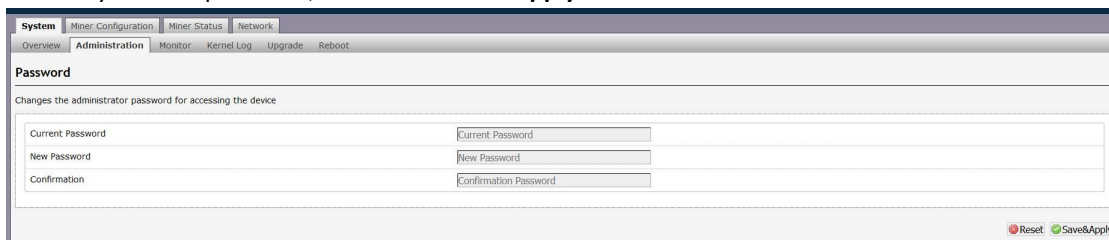

5.4 Restoring Initial Settings

To restore your initial settings

- Turn on the server and let it run for 5 minutes.
- On the controller front panel, press and hold the **Reset** button for 10 seconds.



Resetting your server will reboot it and restore its default settings. The red LED will automatically flash once every 15 seconds if the reset is operated successfully.

Environmental Requirements

Please run your server in accordance with the following requirements

1. Basic Environmental Requirements:

1.1. Climatic Conditions:

Description	Requirement
Operating Temperature	0-40°C
Operating Humidity	10-90%RH (non-condensing)
Storage Temperature	-20-70°C
Storage Humidity	5-95%RH (non-condensing)
Altitude	<2000m

1.2. Site Requirements of the Server Running Room:

Please keep the server running room away from industrial pollution sources:

For heavy pollution sources such as smelters and coal mines, the distance should be more than 5km.

For moderate pollution sources such as chemical industries, rubber and electroplating industries, the distance should be more than 3.7km.

For light pollution sources such as food factories and leather processing factories, the distance should be more than 2km.

If unavoidable, the site should be chosen in the perennial upwind direction of the pollution source.

Please do not set your location within 3.7km from the seaside or the salt lake. If unavoidable, it should be built as airtight as possible, equipped with air conditioning for cooling.

1.3. Electromagnetic Environmental Conditions:

Please keep your site away from transformers, high-voltage cables, transmission lines and high-current equipment, for example, there should be no high-power AC transformers (>10KA) within 20 meters, and no high-voltage power lines within 50 meters.

Please keep your site away from high-power radio transmitters, for example, there should be no high-power radio transmitters (>1500W) within 100 meters.

2. Other Environmental Requirements :

The server running room shall be free of explosive, conductive, magnetically conductive and corrosive dust. The requirements of mechanical active substances are shown below:

2.1 Requirements of Mechanical Active Substances

Mechanical Active Substance	Requirement
Sand	$\leq 30\text{mg}/\text{m}^3$
Dust (suspended)	$\leq 0.2\text{mg}/\text{m}^3$
Dust (deposited)	$\leq 1.5\text{mg}/\text{m}^2\text{h}$

2.2 Requirements of Corrosive Gas

Corrosive Gas	Unit	Concentration
H ₂ S	ppb	< 3
SO ₂	ppb	< 10
Cl ₂	ppb	< 1
NO ₂	ppb	< 50
HF	ppb	< 1
NH ₃	ppb	< 500
O ₃	ppb	< 2

Note: ppb (part per billion) refers to the unit of concentration , 1ppb stands for the volume ratio of part per billion.

Regulations:

FCC Notice (FOR FCC CERTIFIED MODELS):

This device complies with part 15 of the FCC Rules. Operation is subject to the following two conditions: (1) This device may not cause harmful interference, and (2) this device must accept any interference received, including interference that may cause undesired operation.

Note:

This equipment has been tested and found to comply with the limits for a Class A digital device, pursuant to part 15 of the FCC Rules. These limits are designed to provide reasonable protection against harmful interference when the equipment is operated in a commercial environment. This equipment generates, uses, and can radiate radio frequency energy and, if not installed and used in accordance with the instruction manual, may cause harmful interference to radio communications. Operation of this equipment in a residential area is likely to cause harmful interference in which case the user will be required to correct the interference at his own expense.

EU WEEE: Disposal of Waste Equipment by Users in Private Household in the European Union



This symbol on the product or on its packaging indicates that this product must not be disposed of with your other household waste. Instead, it is your responsibility to dispose of your waste equipment by handing it over to a designated collection point for the recycling of waste electrical and electronic equipment. The separate collection and recycling of your waste equipment at the time of disposal will help to conserve natural resources and ensure that it is recycled in a manner that protects human health and the environment. For more information about where you can drop off your waste equipment for recycling, please contact your local city office, your household waste disposal service or the shop where you purchased the product.

台灣 ROHS:

設備名稱: S17,S17 Pro, T17 服務器, 型號: 240-Aa

單元	有害物質					
	鉛 (Pb)	汞 (Hg)	鎘 (Cd)	六價鉻 (Cr+6)	多溴聯苯 (PBB)	多溴二苯醚 (PBDE)
外殼	○	○	○	○	○	○
電路板組件	—	○	○	○	○	○
其他線材	—	○	○	○	○	○
備考 1. “超出 0.1 wt %” 及 “超出 0.01 wt %” 係指限用物質之百分比含量超出百分比含量基準值。 備考 2. “○” 係指該項限用物質之百分比含量未超出百分比含量基準值。 備考 3. “—” 係指該項限用物質為排除項目						