



# DR5 Server Installation Guide

**Document Version 0.1**

**Jan. 2018**

© Copyright Bitmaintech Pte.Ltd. 2007 – 2018. All rights reserved.

Bitmaintech Pte.Ltd. (Bitmain) reserves the right to make corrections, modifications, enhancements, improvements, and other changes to its products and services at any time and to discontinue any product or service without notice.

Customers should obtain the latest relevant information before placing orders and should verify that such information is current and complete. All products are sold subject to Bitmain's terms and conditions of sale supplied at the time of order acknowledgment.

Bitmain warrants performance of its products to the specifications applicable at the time of sale in accordance with Bitmain's standard warranty. Testing and other quality control techniques are used to the extent Bitmain deems necessary to support this warranty. Except where mandated by government requirements, testing of all parameters of each product is not necessarily performed.

Bitmain assumes no liability for third-party applications assistance. Customers are responsible for their products and applications using Bitmain components. To minimize the risks associated with customer products and applications, customers should provide adequate design and operating safeguards.

Bitmain does not warrant or represent that any license, either express or implied, is granted under any Bitmain patent right, copyright or other Bitmain intellectual property right relating to any combination, machine, or process in which Bitmain products or services are used. Information published by Bitmain regarding third-party products or services does not constitute a license from Bitmain to use such products or services or a warranty or endorsement thereof. Use of such information may require a license from a third party under the patents or other intellectual property of the third party, or a license from Bitmain under the patents or other intellectual property of Bitmain.

Resale of Bitmain products or services with statements different from or beyond the parameters stated by Bitmain for that product or service voids all express and any implied warranties for the associated Bitmain product or service and is an unfair and deceptive business practice. Bitmain is not responsible or liable for any such statements.

All company and brand products and service names are trademarks or registered trademarks of their respective holders.

All text and figures included in this publication are the exclusive property of Bitmaintech Pte.Ltd. (Bitmain), and may not be copied, reproduced, or used in any way without the express written permission of Bitmain. Information in this document is subject to change without notice and does not represent a commitment on the part of Bitmain. Although the information in this document has been carefully reviewed, Bitmain does not warrant it to be free of errors or omissions. Bitmain reserves the right to make corrections, updates, revisions or changes to the information in this document.

Bitmaintech Pte.Ltd.  
Tel:+86-400-890-8855  
[www.bitmain.com](http://www.bitmain.com)

---

## Table of Contents

---

<b>1. Overview</b> .....	<b>4</b>
1.1 DR5 Server Components .....	5
1.2 Specifications .....	7
<b>2. Setting Up the Server</b> .....	<b>9</b>
<b>3. Configuring the Server</b> .....	<b>11</b>
<b>4. Monitoring Your Server</b> .....	<b>11</b>
<b>5. Administering Your Server</b> .....	<b>13</b>
5.1 Checking Your Firmware Version .....	13
5.2 Upgrading Your System .....	13
5.3 Modifying Your Pass Word .....	14
5.4 Restoring initial Settings .....	14

## 1. Overview

The DR5 server is Bitmain's newest version in the DR5 server series. Power supply APW8 is part of DR5 server. All DR5 servers are tested and configured prior to shipping to ensure easy set up.

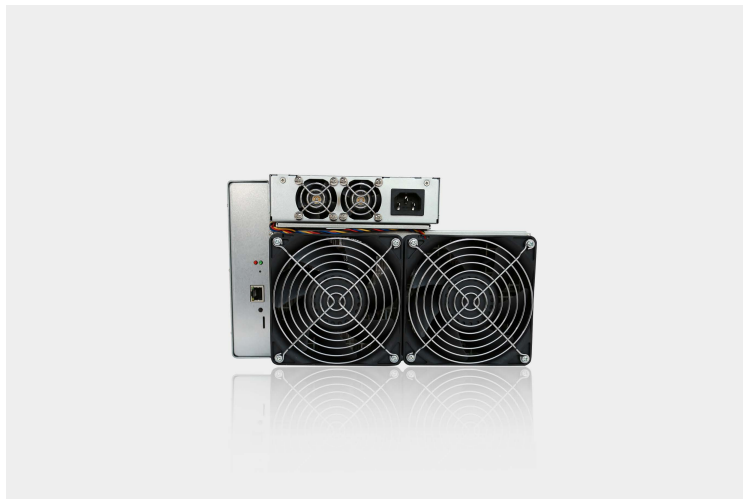
**Caution:**

1. The socket-outlet shall be installed near the equipment and shall be easily accessible.
2. Please refer to the layout above to place your goods in usage in case of any damage.

### 1.1 DR5 Server Components

The DR5 server main components and controller front panel are shown in the following figure:

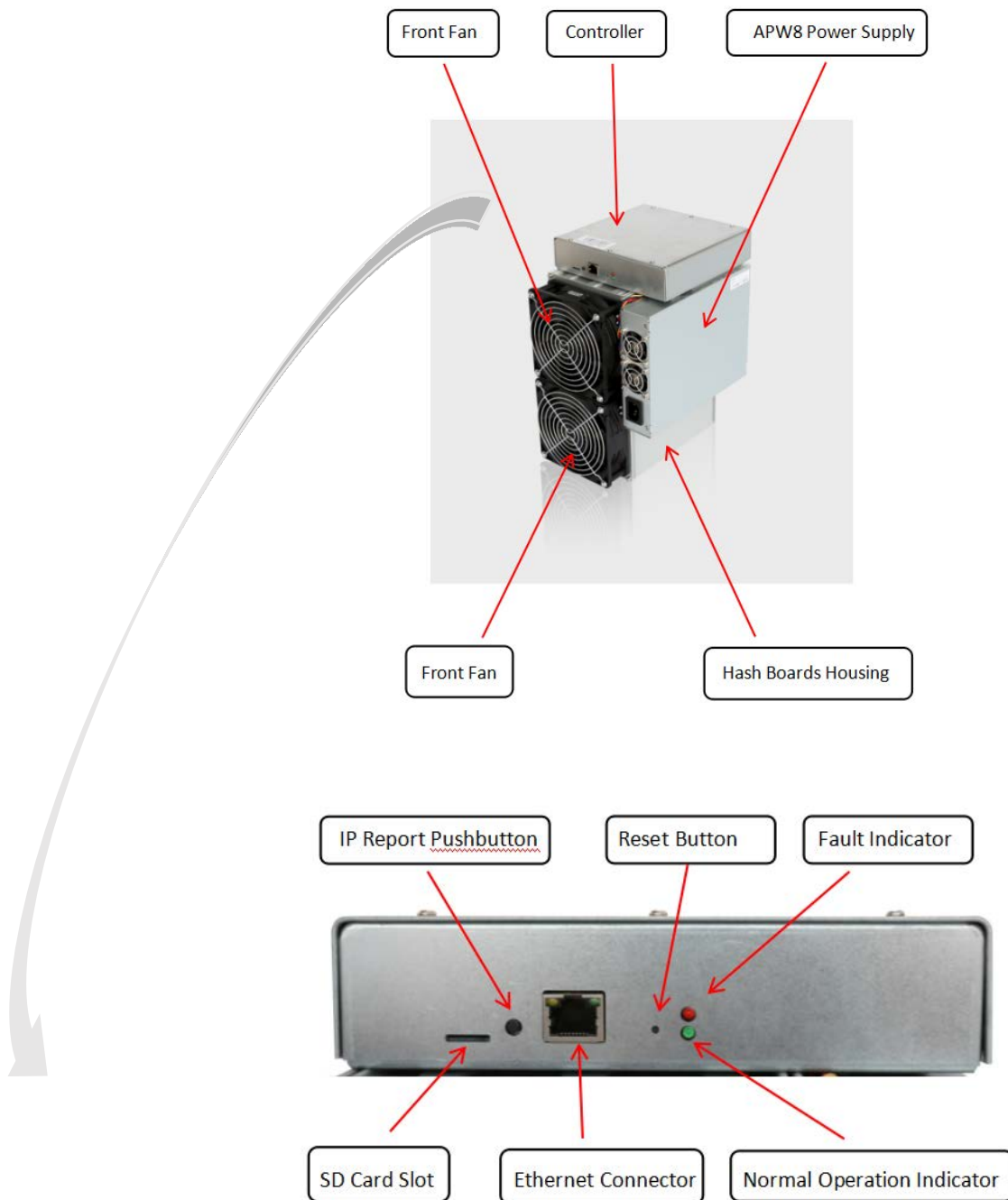

### APW8 Power Supply:

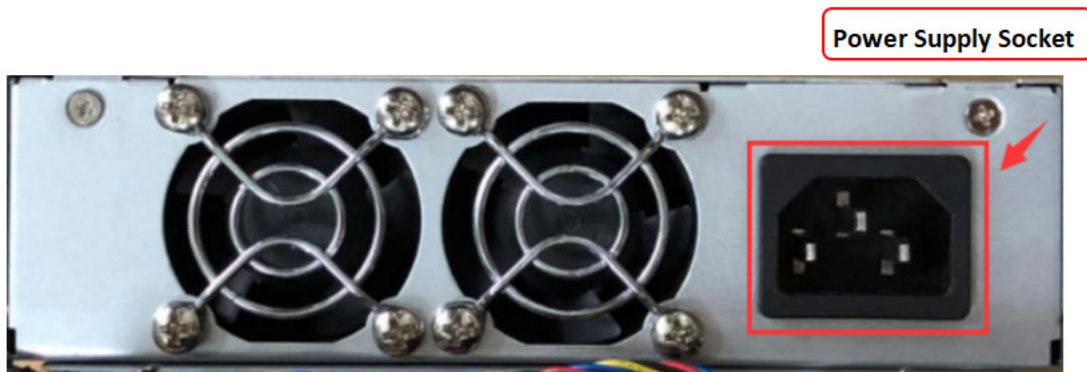

**Note:**

1. Power supply APW8 is part of DR5 server. For detailed parameters, please refer to the specifications below.
2. Additional power cord is needed.

## 1.2 Specifications

Product Glance		Value		
Crypto Algorithm		Blake256R14		
Hashrate, TH/s		Normal	Low Power	
		35.00	25.00~26.00	
Reference power on wall, Watt		1610	1000~1040	
Reference power efficiency on wall @25°C, J/TH		46.00	40.00	
Detailed Characteristics		Value		
		Min	Typ	Max
Hashrate & Power				
Hashrate, TH/s	Normal	35.00	35.95	
	Low Power	25~26.00	+3% (1-1)	
Power efficiency on wall @25°C, J/TH	Normal	46.00	49.22	
	Low Power	40.00	42.80	
Power efficiency on wall @40°C, J/TH	Normal	47.53	50.86	
	Low Power	41.42	44.32	
Power on wall, Watt (1-1)	Normal	1610	1828	
	Low Power	1000	1187	
Power supply AC input voltage, Volt (1-2)		200	220	240
Power supply AC input current, Amp(1-3)	Normal	7.32	9.14	
	Low Power	4.55	5.94	
Power supply Input AC Frequency Range, Hz		47	50	63
Hardware Configuration				
Quantity of hash chips		216		
Quantity of hash boards		3		
Networking connection mode		RJ45 Ethernet 10/100M		
Miner Size (Length*Width*Height, w/o package),mm(2-1)		238*178*297		
Net weight, kg (2-2)		7.75		

Noise, dBA @25°C (2-3)	76		
Environment Requirements			
Operation temperature, °C	0	25	40
Storage temperature, °C	-40	25	85
Operation humidity, RH	5%		95%

**Notes:**

- (1-1) In Low Power Mode, Max Hashrate should be Typ hashrate \*103%
- (1-2) Min condition: 25°C, min J/TH, typical hashrate Max condition: 40°C, max J/TH, max hashrate
- (1-3) **Caution: Wrong input voltage may probably cause miner damaged**
- (1-4) Typ condition: min reference power, typical AC input voltage Max condition: max reference power, min AC input voltage
- (2-1) Including PSU size
- (2-2) Including PSU weight
- (2-3) Max condition: Fan is under max RPM(rotation per minute).

**Specifications for APW8:**

<b>Input</b>	Voltage Range	200-240V AC
	Frequency Range	50/60Hz
	Power Factor	>0.99
	Leakage Current	<2mA
	Overheat Protection	Yes
<b>Environment</b>	Operating Temperature	0°C-40°C
	Operating Humidity	5%RH-95%RH(non---condensing)
<b>Cooling System</b>	Fan	forced---air cooling



## 2. Setting Up the Server

To set up the server:

 The file IPReporter.zip is supported by Microsoft Windows only.

1. Go to the following site:  
<https://shop.bitmain.com/support.htm?pid=00720160906053730999PVD2K0vz0693>
2. Download the following file: IPReporter.zip
3. Extract the file.

 The default DHCP network protocol distributes IP addresses automatically.

4. Right-click **IPReporter.exe** and run it as Administrator.
5. Select one of the following options:
  - Shelf, Step, Position – suitable for farm servers to mark the location of the servers.
  - Default – suitable for home servers.
6. Click **Start**.

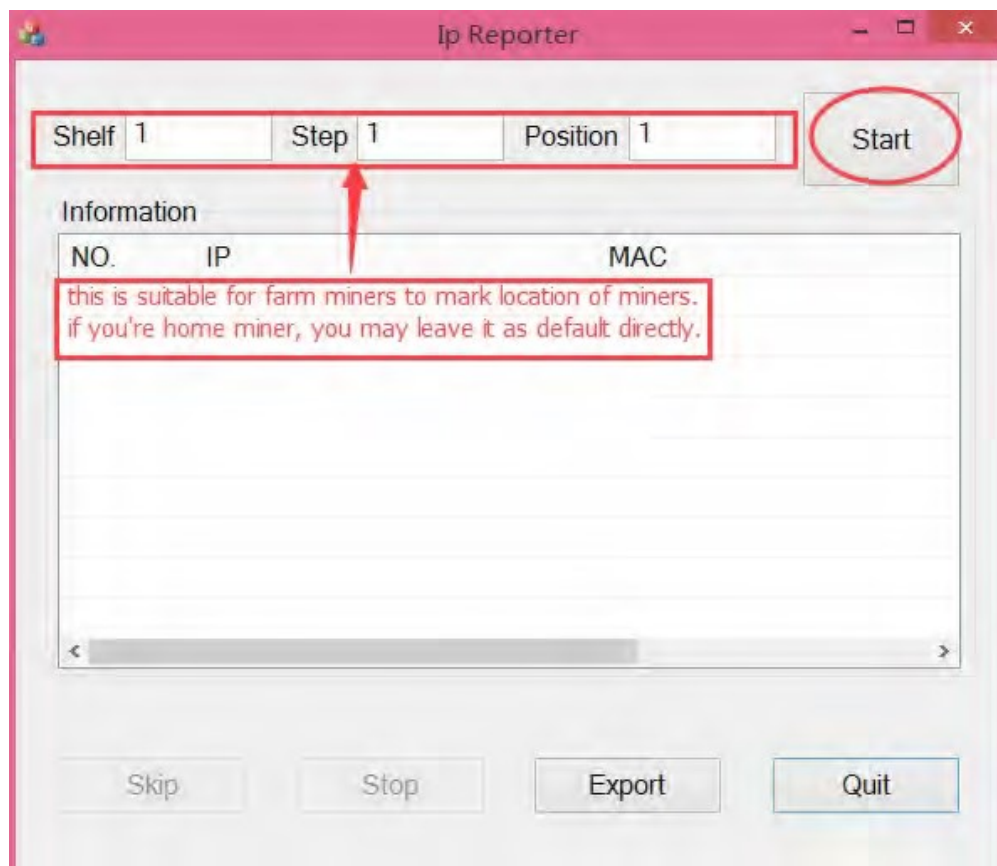

2. Setting Up the server

- On the controller board, click the IP Report button. Hold it down until it beeps (about 5 seconds).

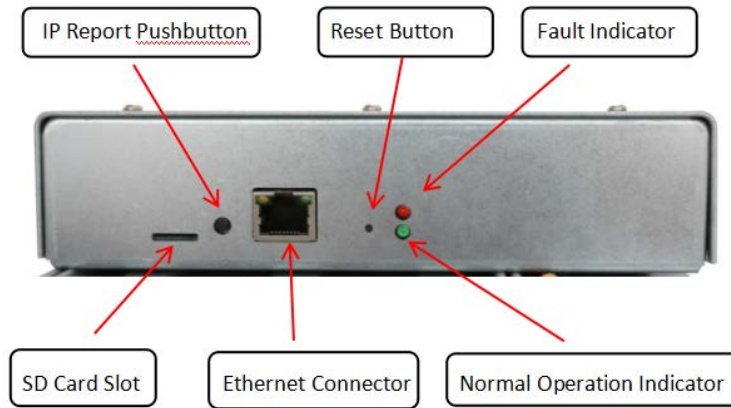

The IP address will be displayed in a window on your computer screen.

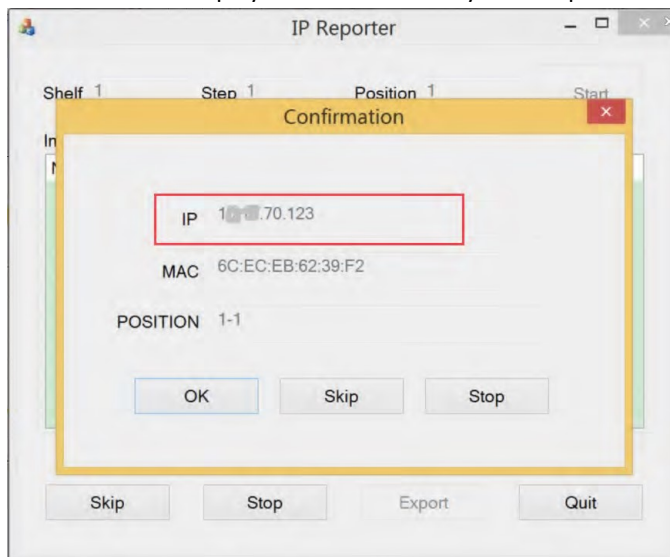

- In your web browser, enter the IP address provided.
- Proceed to login using `root` for both the username and password.
- In the Network section, you can assign a DHCP IP address (optional).
- Click **Save & Apply**.

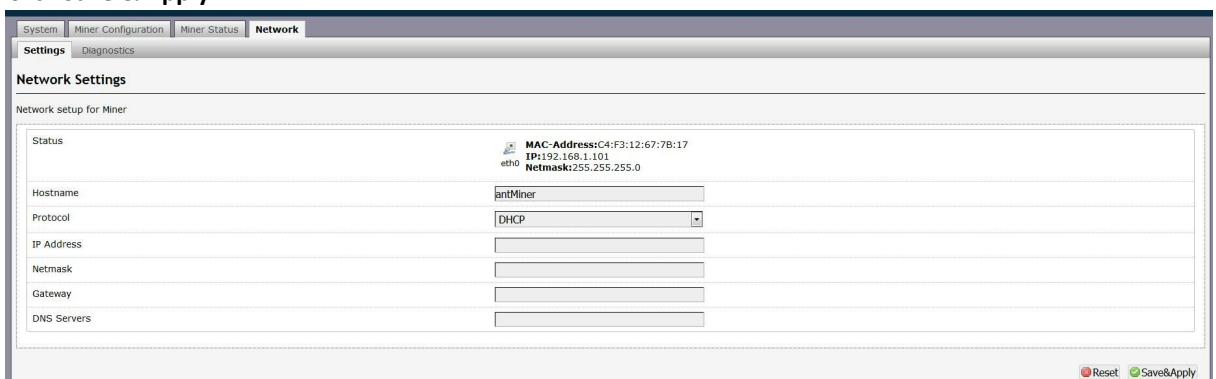



### 3. Configuring the Server

#### Setting Up the Pool

To configure the server:

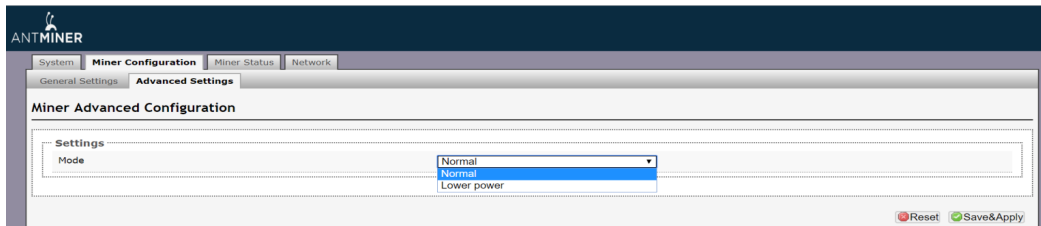
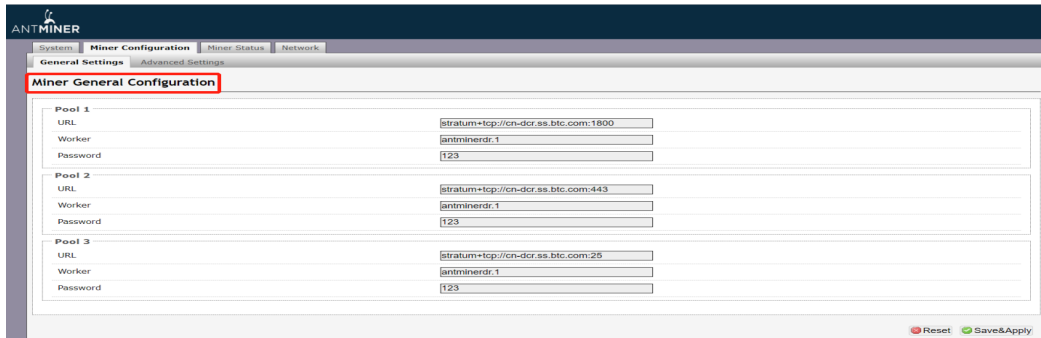
1. click **General Settings**.



 **Note:** There are two modes of Hashrate which you may adjust: Normal and Low power. Power consumption varies with different mode. Please refer to the specifications above for more information.

2. Set the options according to the following table:

Option	Description
Pool URL	Enter the URL of your desired pool. <div style="border: 1px solid black; padding: 10px; margin-top: 10px;">  <p>The DR5 server can be set up with three mining pools, with decreasing priority from the first pool (pool 1) to the third pool (pool 3). The pools with low priority will only be used if all higher priority pools are offline.</p> </div>
Worker	Your worker ID on the selected pool.
Password	The password for your selected worker.

3. Click **Save & Apply** to save and restart the server.

## 4. Monitoring Your server

To check the operating status of your server:

1. Click the status marked below.

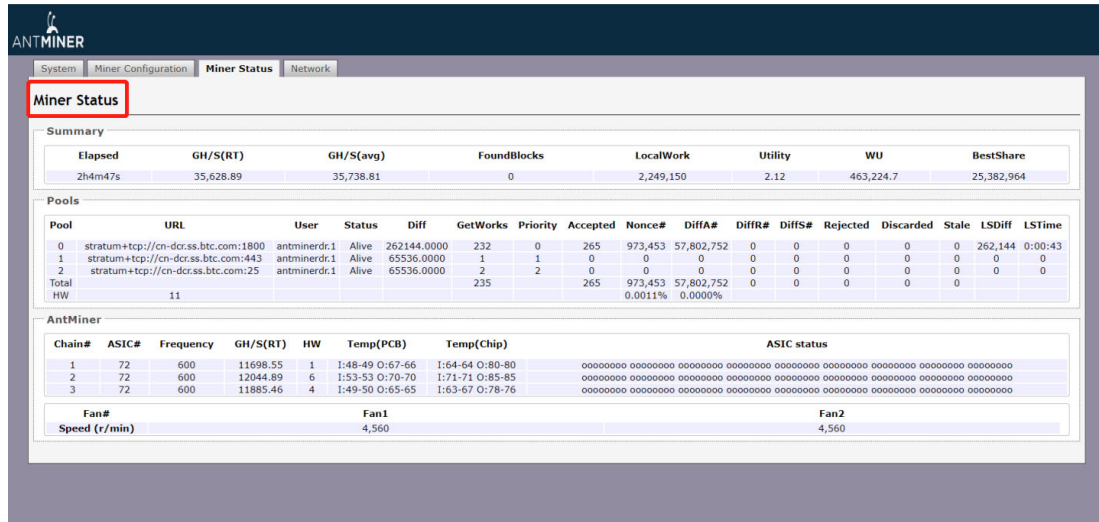

The screenshot shows the AntMiner web interface with the 'Miner Status' tab selected. The 'Miner Status' tab is highlighted with a red box. The interface displays a summary of mining statistics, a table of mining pools, and a detailed view of the AntMiner hardware status including ASICs and fans.

 **Note:** The DR5 server is with fixed frequency adjustment 600 MHZ. Firmware will stop running when the Temp(chips) reaches to 100°C , there will be an error message “Fatal Error: Temperature is too high!” shown in the bottom of kernel log page.

2. monitor your server according to the descriptions in the following table:

Option	Description
ASIC#	Number of chips detected in the chain.
Frequency	ASIC frequency setting.
GH/S(RT)	Hash rate of each hash board ( GH/s)
Temp(PCB)	Temperature of each hash board (°C).(Applied only to server with fixed frequency)
Temp(Chip)	Temperature of the chips on each hash board (°C).
ASIC status	One of the following statuses will appear: <ul style="list-style-type: none"> <li>● O - indicates OK</li> <li>● X - indicates error</li> <li>● - - indicates dead</li> </ul>

## 5. Administering Your Server

### 5.1 Checking Your Firmware Version

To check your firmware version:

1. In **System**, click the **Overview** tab.
2. **File System Version** displays the date of the firmware your server use. In the example below, the server is using firmware version 20181211.

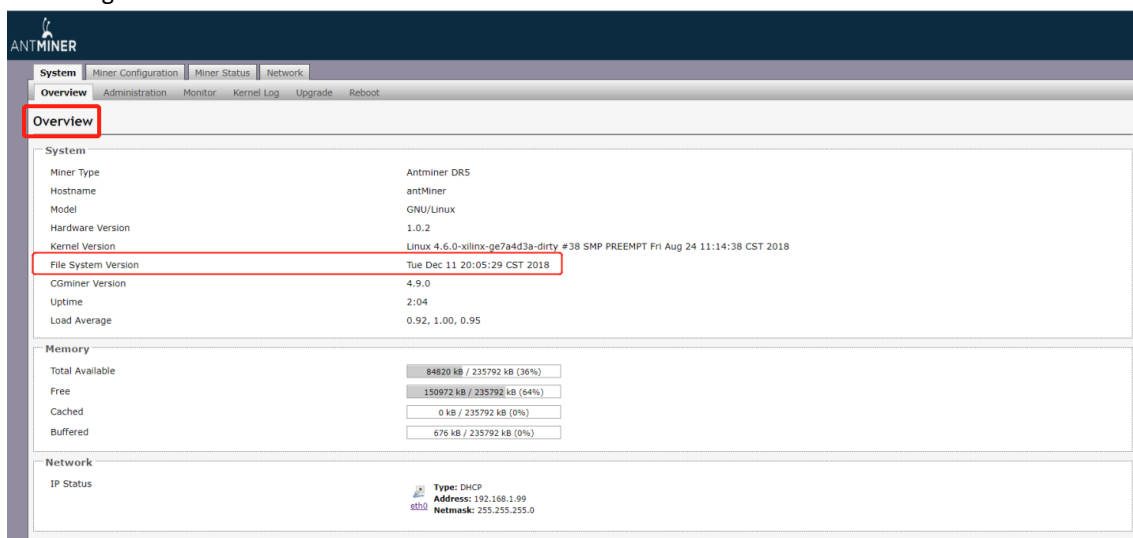

The screenshot shows the Antminer DR5 web interface. The 'System' menu is open, and the 'Overview' sub-menu is selected. The 'File System Version' is highlighted with a red box, indicating the current firmware version is 'Tue Dec 11 20:05:29 CST 2018'. Other system information includes Miner Type (Antminer DR5), Hostname (antMiner), Model (GNU/Linux), Hardware Version (1.0.2), Kernel Version (Linux 4.6.0-xilinx-ge7a4d3a-dirty #38 SMP PREEMPT Fri Aug 24 11:14:38 CST 2018), CGminer Version (4.9.0), Uptime (2:04), Load Average (0.92, 1.00, 0.95), Memory usage (Total Available: 84820 kB / 235792 kB (36%), Free: 150972 kB / 235792 kB (64%), Cached: 0 kB / 235792 kB (0%), Buffered: 676 kB / 235792 kB (0%)), and Network status (IP Status: Type: DHCP, Address: 192.168.1.99, Netmask: 255.255.255.0).

### 5.2 Upgrading Your System



Make sure that the DR5 server remains powered during the upgrade process. If power fails before the upgrade is completed, you will need to return it to Bitmain for repair.

To upgrade the server's firmware:

1. In **System**, click **Upgrade**.

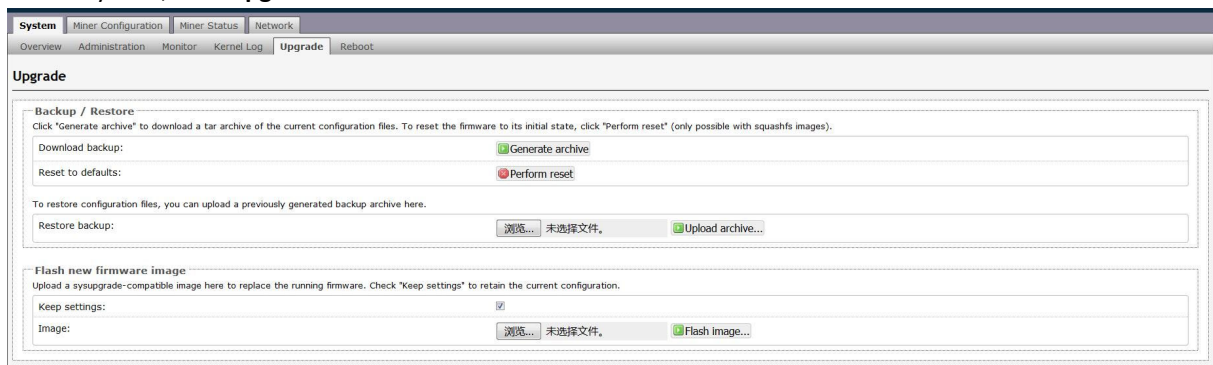

The screenshot shows the Antminer DR5 web interface with the 'Upgrade' sub-menu selected. The page is divided into two main sections: 'Backup / Restore' and 'Flash new firmware image'. In the 'Backup / Restore' section, there are buttons for 'Generate archive' and 'Perform reset'. In the 'Flash new firmware image' section, there is a checkbox for 'Keep settings' (checked) and a 'Flash Image...' button. The 'Restore backup' section has a file selection button and an 'Upload archive...' button.

2. For **Keep Settings**:
  - Select the check box to keep your current settings (default).
  - Clear the check box to reset the server to default settings.
3. Click the 选择文件 (**Browse**) button and navigate to the upgrade file. Select the upgrade file, then click **Flash image**. A message appears notifying you if the DR5 firmware can be upgraded and if yes, will then proceed to flash the image.
4. When the upgrade is completed, the following message appears:

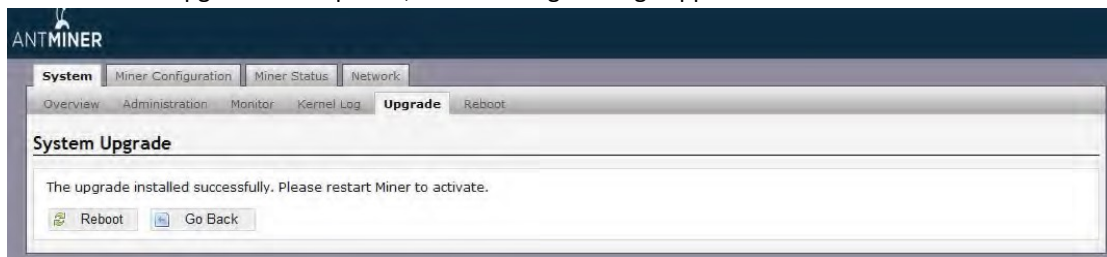

5. Click one of the following options:
  - **Reboot** - to restart the server with the new firmware.
  - **Go Back** - to continue mining with the current firmware. The server will load the new firmware next time it is restarted.

### 5.3 Modifying Your Password

To change your login password:

1. In **System**, click the **Administration** tab.
2. Set your new password, then click **Save & Apply**.

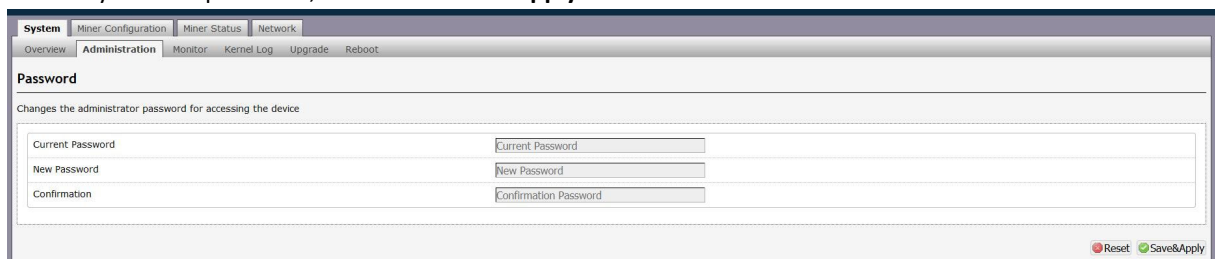

### 5.4 Restoring Initial Settings

To restore your initial settings

1. Turn on the server and let it run for 5 minutes.
2. On the controller front panel, press and hold the **Reset** button for 10 seconds.



Resetting your server will reboot it and restore its default settings. The red LED will automatically flash once every 15 seconds if the reset is operated successfully.

**Regulation:**

**FCC Notice (FOR FCC CERTIFIED MODELS):**

This device complies with part 15 of the FCC Rules. Operation is subject to the following two conditions: (1) This device may not cause harmful interference, and (2) this device must accept any interference received, including interference that may cause undesired operation.

**Note:**

This equipment has been tested and found to comply with the limits for a Class A digital device, pursuant to part 15 of the FCC Rules. These limits are designed to provide reasonable protection against harmful interference when the equipment is operated in a commercial environment. This equipment generates, uses, and can radiate radio frequency energy and, if not installed and used in accordance with the instruction manual, may cause harmful interference to radio communications. Operation of this equipment in a residential area is likely to cause harmful interference in which case the user will be required to correct the interference at his own expense.

**EU WEEE: Disposal of Waste Equipment by Users in Private Household in the European Union**



This symbol on the product or on its packaging indicates that this product must not be disposed of with your other household waste. Instead, it is your responsibility to dispose of your waste equipment by handing it over to a designated collection point for the recycling of waste electrical and electronic equipment. The separate collection and recycling of your waste equipment at the time of disposal will help to conserve natural resources and ensure that it is recycled in a manner that protects human health and the environment. For more information about where you can drop off your waste equipment for recycling, please contact your local city office, your household waste disposal service or the shop where you purchased the product.

**台灣 ROHS:**

設備名稱： \_\_\_\_\_ ， 型號： \_\_\_\_\_

單元	有害物質					
	鉛 (Pb)	汞 (Hg)	鎘 (Cd)	六價鉻 (Cr+6)	多溴聯苯 (PBB)	多溴二苯 醚 (PBDE)
外殼	○	○	○	○	○	○
電路板組 件	—	○	○	○	○	○
其他線材	—	○	○	○	○	○

備考 1. “超出 0.1 wt %” 及 “超出 0.01 wt %” 係指限用物質之百分比含量超出百分比含量基準值。

備考 2. “○” 係指該項限用物質之百分比含量未超出百分比含量基準值。

備考 3. “—” 係指該項限用物質為排除項目